

# ERECT

## ERECT MOBİLYA HIRDAVAT

SANAYİ İÇ VE DIŞ TİCARET LTD. ŞTİ.

### FURNITURE ACCESSORIES

[www.erecturkey.com.tr](http://www.erecturkey.com.tr)

PBN

OFFICE CHAIR CASTER WHEEL

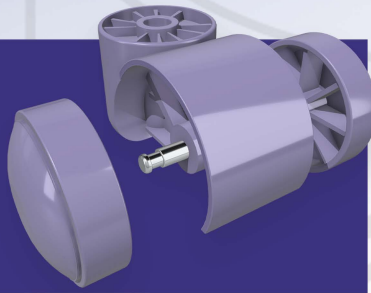

**PBN11P**



**PBN69P**



**PBN38C**

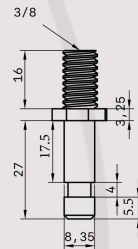
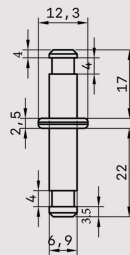
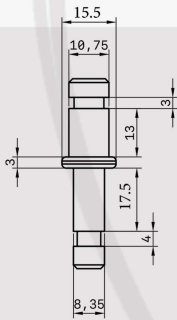

MODEL															COLOR
PBN11P	50	—	—	60	—	40	—	—	—	21	—	—	—	—	BLACK
PBN69P	50	—	—	—	59.5	40	—	—	—	—	—	17	—	—	BLACK
PBN38C	50	—	60	—	—	40	—	—	—	—	16	—	—	—	BLACK



**PBN DT**



**PBN UU**



**PBN KU**



**PBN M8C**

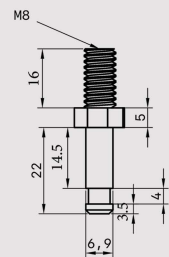
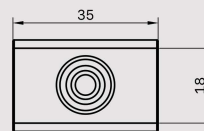
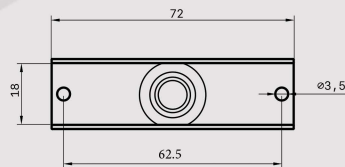
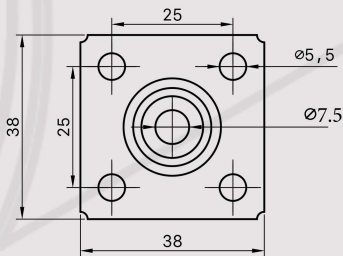

MODEL															COLOR
PBN DT	50	63	—	—	—	40	38×38	25×25	5.5	—	—	—	—	—	BLACK
PBN UU	50	63	—	—	—	40	72×21	62.5	3.5	—	—	—	—	18	BLACK
PBN KU	50	63	—	—	—	40	35×21	—	3.5	—	—	—	18	—	BLACK
PBN M8C	50	—	62	—	—	40	—	—	—	—	16	—	—	—	BLACK

PBPVC

SILENT CASTER WHEEL - PVC

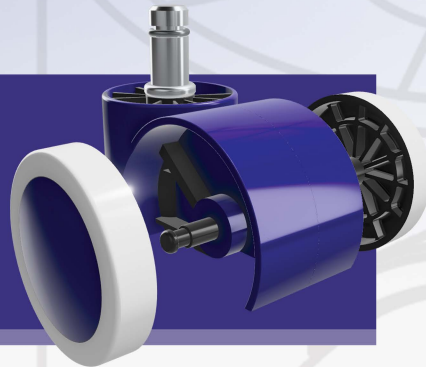

PVCSN11P



PVCGN11P



PVCBN11P



PVCSN11P

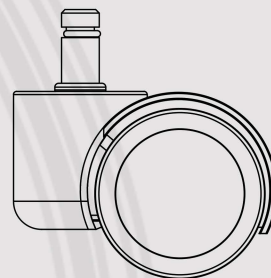
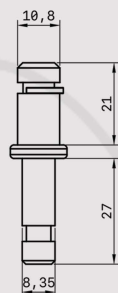

Model														COLOR
PVCSN11P	48.5	PVC	—	60	—	40	—	—	—	21	—	—	—	BLACK
PVCGN11P	48.5	PVC	—	60	—	40	—	—	—	21	—	—	—	GREY
PVCBN11P	48.5	PVC	—	60	—	40	—	—	—	21	—	—	—	WHITE



**P60**

**OFFICE CHAIR CASTER WHEEL**

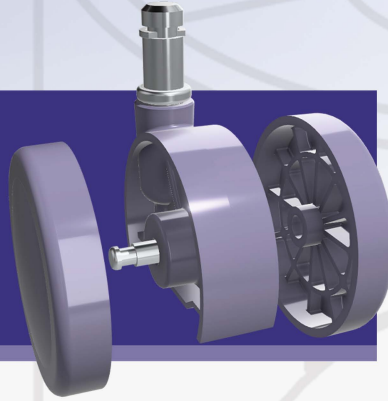

**P60N11P**

**P60JS11P**



**P60JK11P**

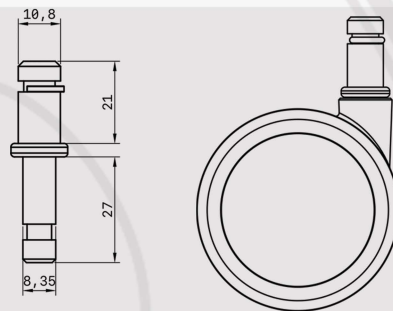

Model															COLOR
P60N11P	60	—	—	67	—	40	—	—	—	21	—	—	—	—	BLACK
P60JS11P	60	—	—	67	—	40	—	—	—	21	—	—	—	—	BLACK
P60JK11P	60	—	—	67	—	40	—	—	—	21	—	—	—	—	RED



**P50**

**FURNITURE CASTER WHEEL 50 MM**

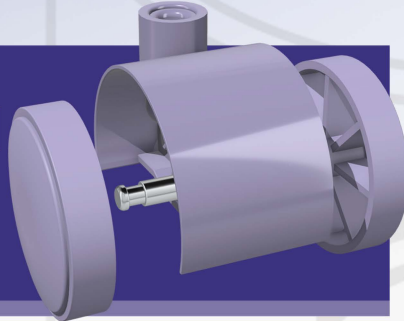

**P50N11P**



**P50NM8C**



**P50N69P**

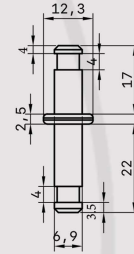
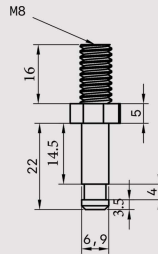
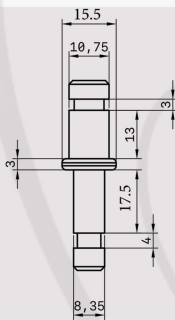

Model															COLOR
P50N11P	50	—	—	64.5	—	40	—	—	—	21	—	—	—	—	BLACK
P50NM8C	50	—	66	—	—	40	—	—	—	—	16	—	—	—	BLACK
P50N69P	50	—	—	—	65	40	—	—	—	—	—	17	—	—	BLACK



## P50NDT



## P50NKU



## P50NUU



## P50N38C

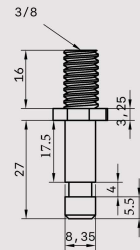
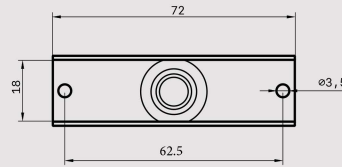
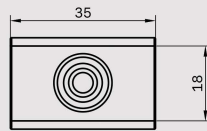
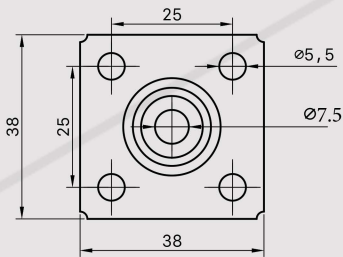

Model															COLOR
P50NDT	50	67.5	—	—	—	40	38×38	25×25	5.5	—	—	—	—	—	BLACK
P50NKU	50	67.5	—	—	—	40	35×21	—	3.5	—	—	—	18	—	BLACK
P50NUU	50	67.5	—	—	—	40	72×21	62.5	3.5	—	—	—	—	18	BLACK
P50N38C	50	—	64.5	—	—	40	—	—	—	—	16	—	—	—	BLACK

P40

FURNITURE CASTER WHEEL 40 MM

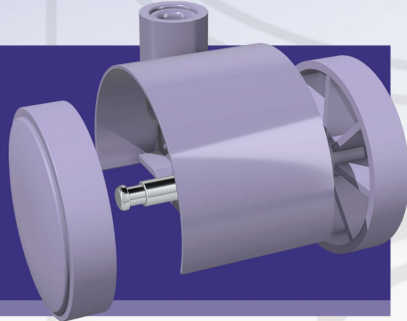

**P40NDT**



**P40NM8C**



**P40NUU**



**P40N69P**

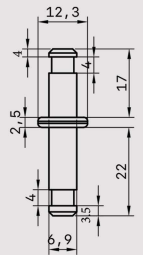
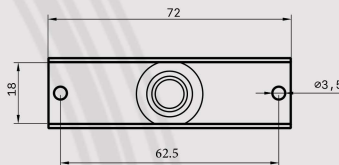
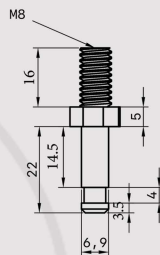
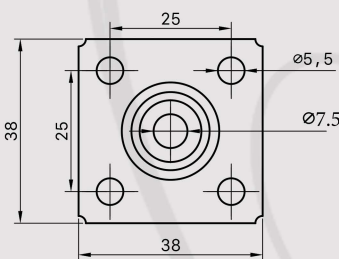

Model															COLOR
P40NDT	40	51	—	—	—	30	38×38	25×25	5.5	—	—	—	—	—	BLACK
P40NM8C	40	—	49	—	—	30	—	—	—	16	—	—	—	—	BLACK
P40NUU	40	51	—	—	—	30	72×21	62.5	3.5	—	—	—	—	18	BLACK
P40N69P	40	—	—	—	47	30	—	—	—	—	—	17	—	—	BLACK

**P40NKU**



**P40NS69P**

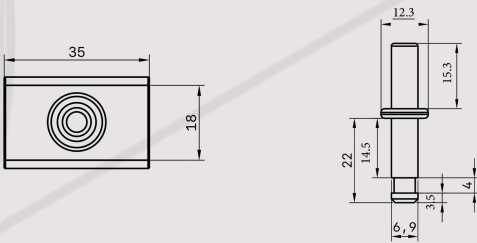

Model																COLOR
P40NKU	40	51	—	—	—	30	35×21	—	3.5	—	—	—	18	—	—	BLACK
P40NS69P	40	—	—	—	47	30	—	—	—	—	—	15.3	—	—	—	BLACK

**PPA**

**OFFICE PLASTIC FIXED LEG**



**PPA11P**



**PPA38C**



**PPA69P**

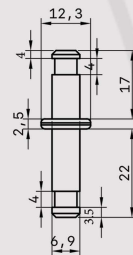
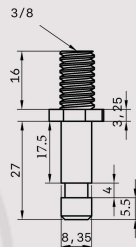
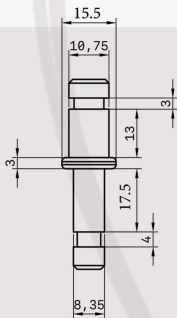

MODEL																COLOR
PPA11P	37	-	-	-	-	50	-	-	-	21	-	-	-	-	-	BLACK
PPA38C	37	-	35.5	-	-	50	-	-	-	-	16	-	-	-	-	BLACK
PPA69P	37	-	-	-	34	50	-	-	-	-	-	17	-	-	-	BLACK



**PPADT**



**PPAM8C**



**PPAUU**



**PPAKU**

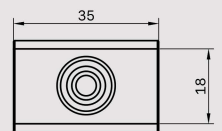
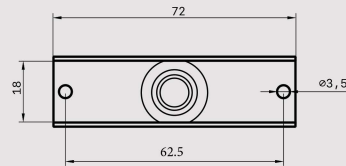
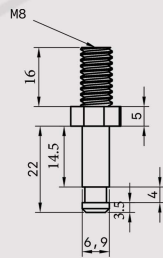
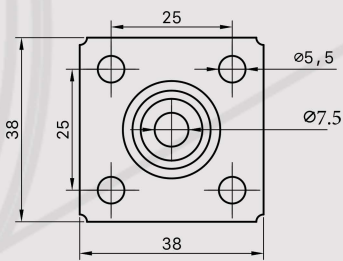

MODEL															COLOR
PPADT	37	40	—	—	50	38×38	25×25	5.5	—	—	—	—	—	—	BLACK
PPAM8C	37	—	37	—	50	—	—	—	—	16	—	—	—	—	BLACK
PPAUU	37	40	—	—	50	72×21	62.5	3.5	—	—	—	—	18	—	BLACK
PPAKU	37	40	—	—	50	35×21	—	3.5	—	—	—	18	—	—	BLACK

**M5020**

**50x20 SWIVEL CASTER**

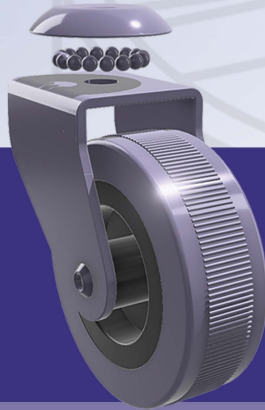

**M5020NDT**



**M5020NKU**



**M5020N38C**

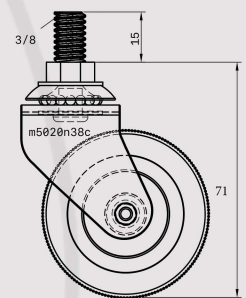
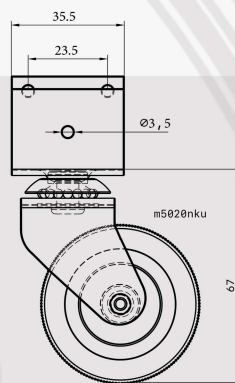
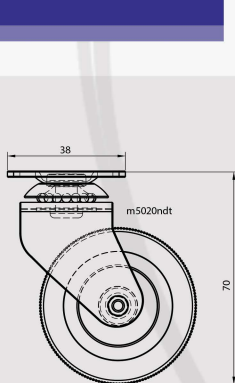

MODEL																
M5020NDT	50x20	PVC	—	—	—	70	—	—	—	—	—	—	2		30	WHITE
M5020NKU	50x20	PVC	—	—	—	67	18	—	—	—	—	—	2		30	WHITE
M5020N38C	50x20	PVC	71	—	—	—	—	—	—	15	—	—	2		30	WHITE



## M5020UU



## M5020NST

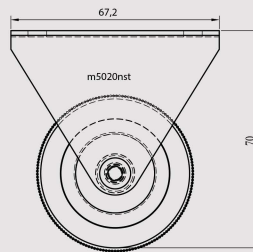
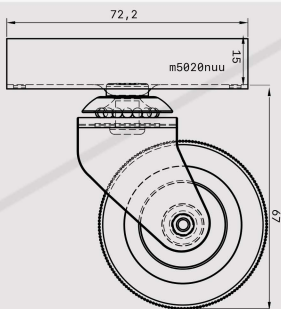
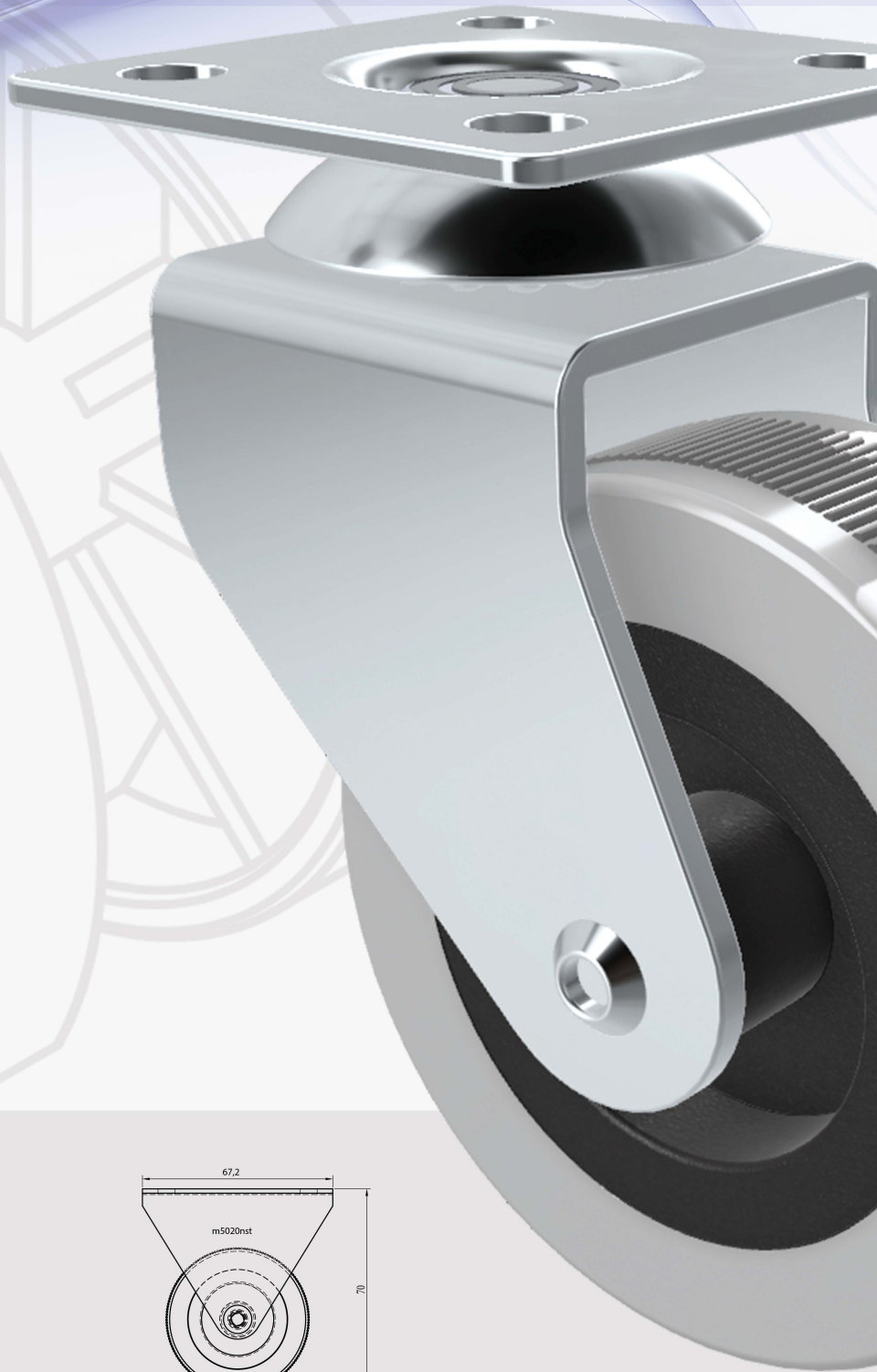

MODEL															COLOR
M5020UU	50×20	PVC	—	—	—	67	—	18	—	—	—	2		30	WHITE
M5020NST	50×20	PVC	—	—	—	70	—	—	—	—	—	2	—	30	WHITE

**M5020F**

**50×20 SWIVEL CASTER WITH BRAKE**

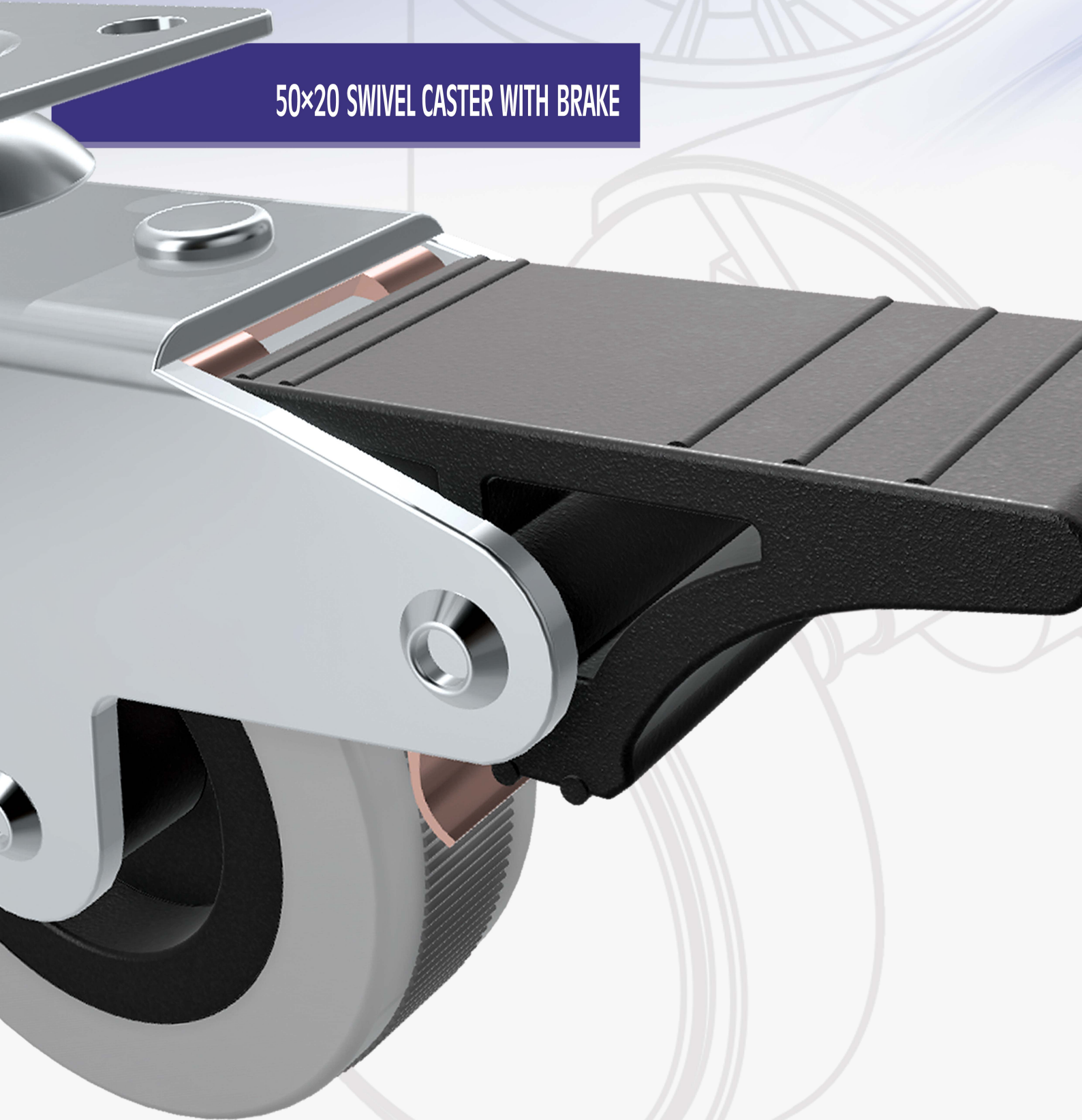





**M5020FDT**



**M5020FKU**

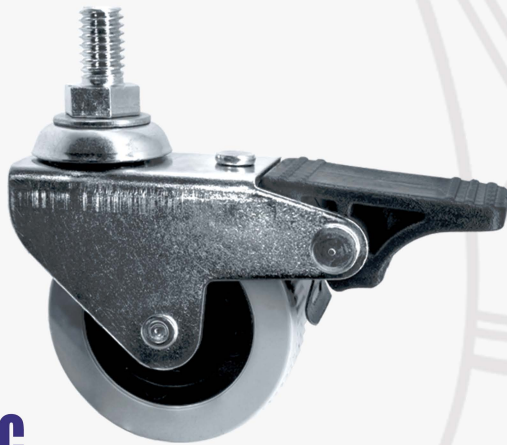

**M5020F38C**



**M5020FUU**

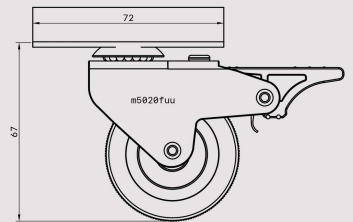
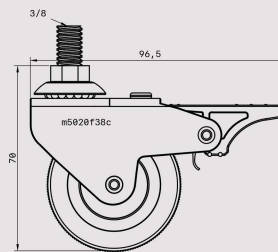
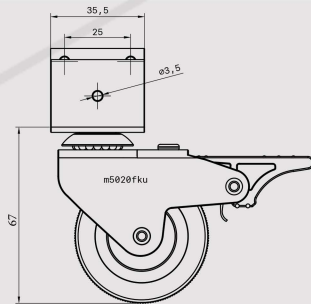
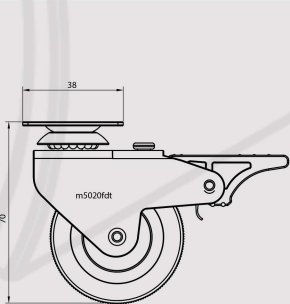

MODEL															COLOR
M5020FDT	50×20	PVC	—	—	—	70	—	—	—	—	—	2		30	WHITE
M5020FKU	50×20	PVC	—	—	—	67	18	—	—	—	—	2		30	WHITE
M5020F38C	50×20	PVC	70	—	—	—	—	—	—	15	—	2		30	WHITE
M5020FUU	50×20	PVC	—	—	—	67	—	18	—	—	—	2		30	WHITE

**MST**

**FIXED CASTER WHEELS**

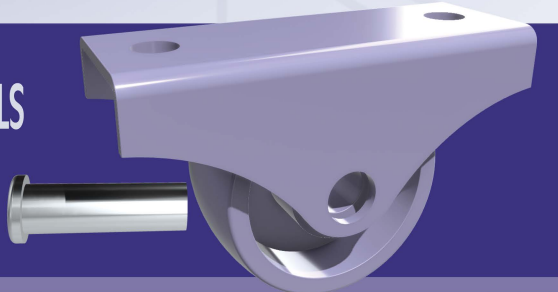

**MST66**



**MST50**



**MST45**

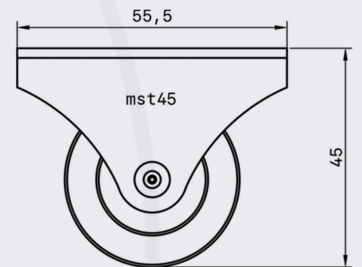
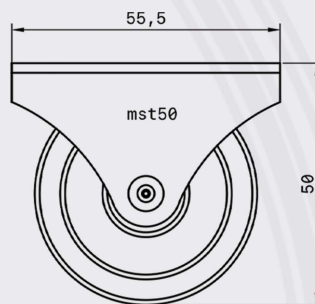
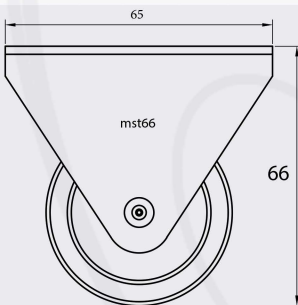

MODEL								COLOR
MST66	46	16.5	66	66	28	1.5	30	BLACK
MST50	46	16.5	50	55.5	22	1.25	30	BLACK
MST45	36	13.3	45	55.5	22	1.25	30	BLACK

**MST40**



**MST28**

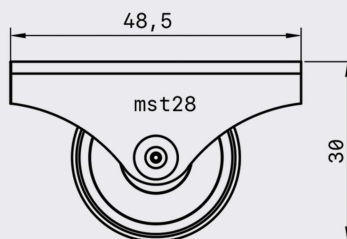
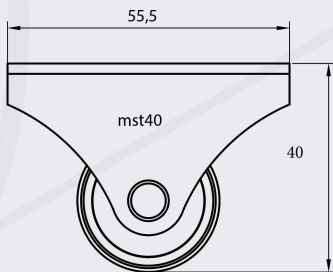

MODEL								COLOR
MST40	28	14	40	55.5	22	1.25	30	BLACK
MST28	28	14	30	48.5	19	1.25	30	BLACK

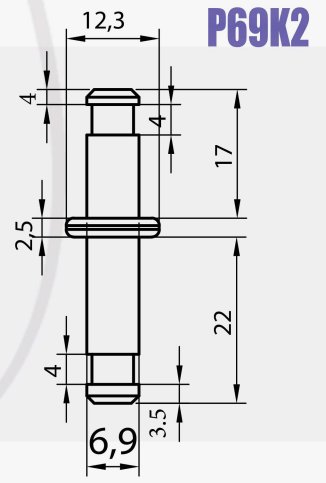
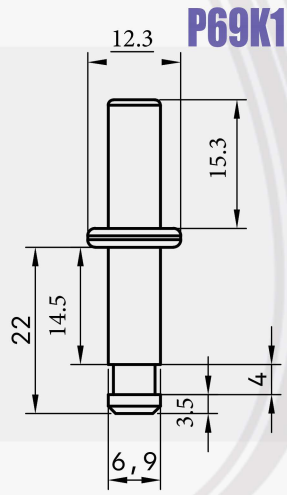
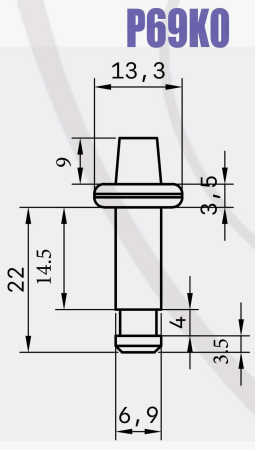
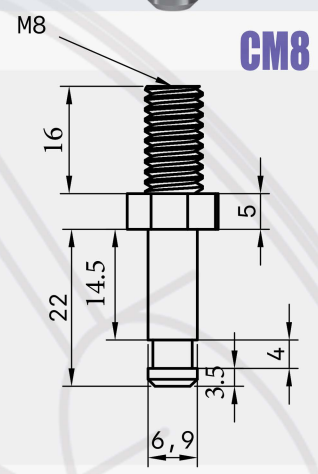
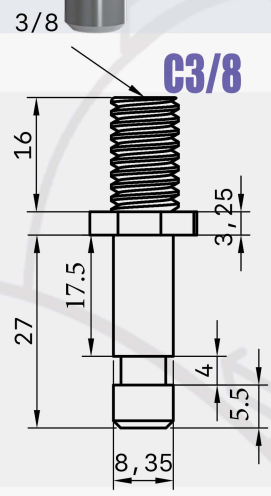
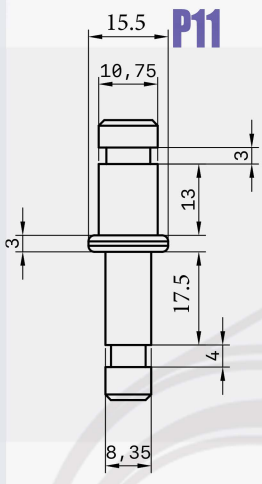



**OP50**

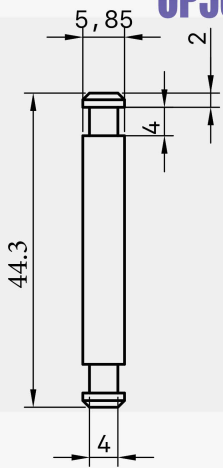

**OP40**

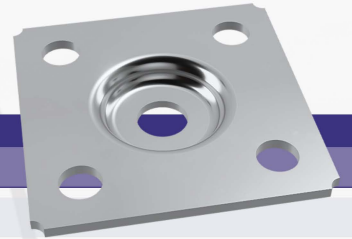
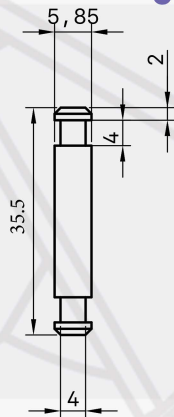

**S38-15**

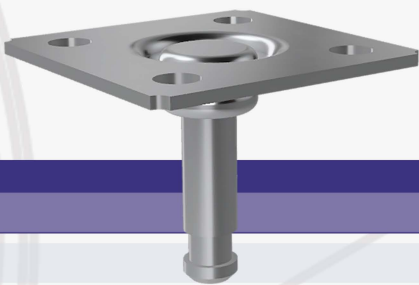
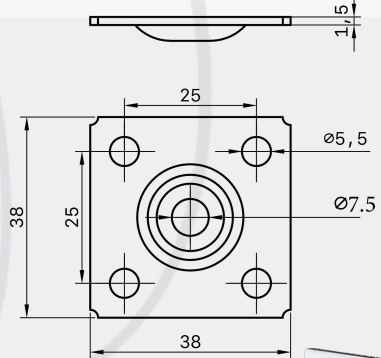

**DT38-15**

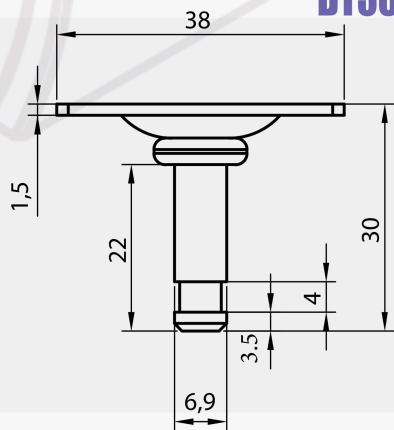

**UG18U**

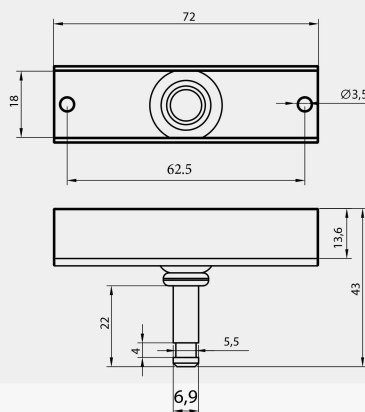

**UG18K**

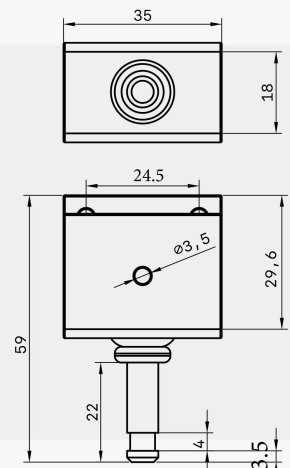

TECHNICAL

MST66

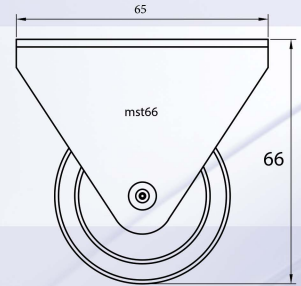
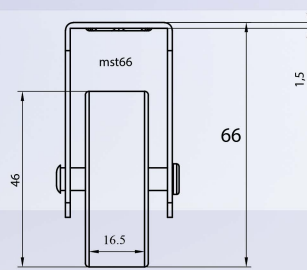
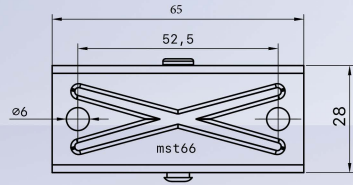
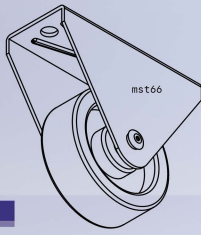

MST50

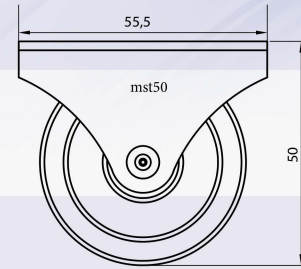
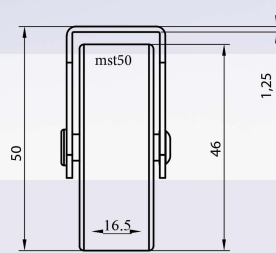
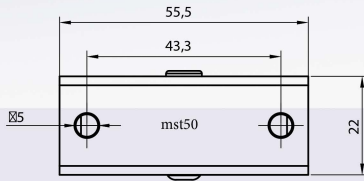
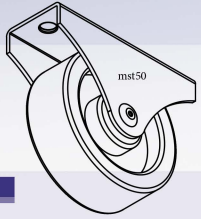

MST45

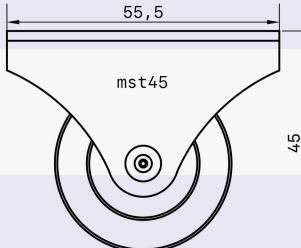
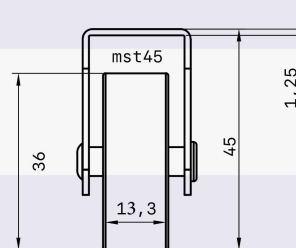
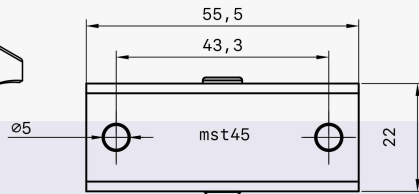
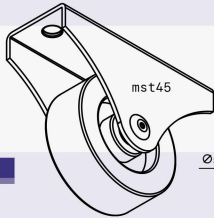

MST40

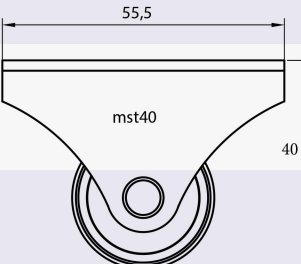
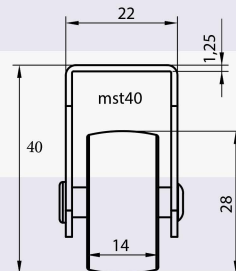
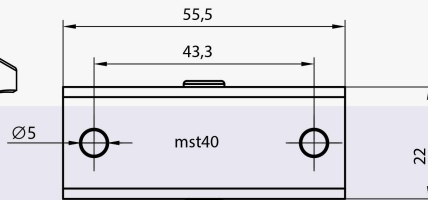
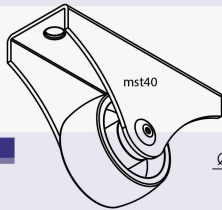

MST28

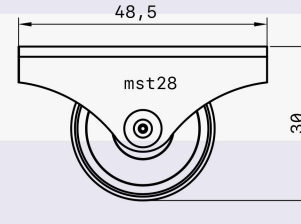
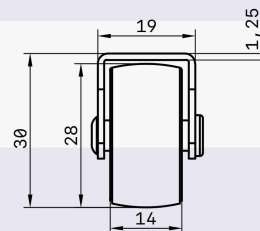
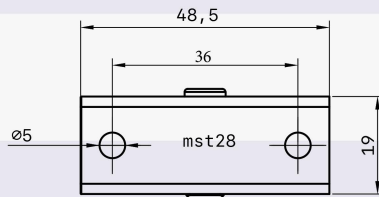
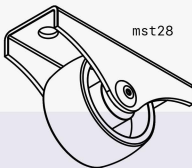

M5020NDT

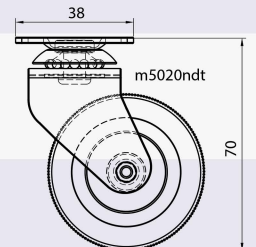
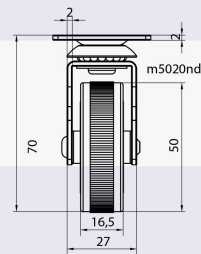
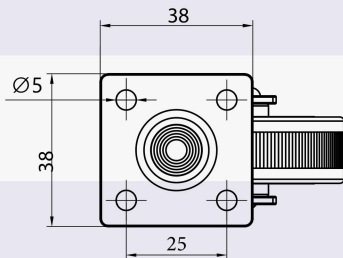
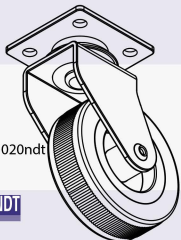

M5020N38C

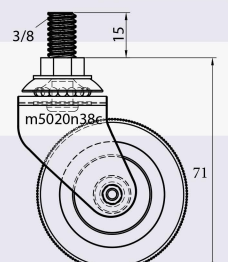
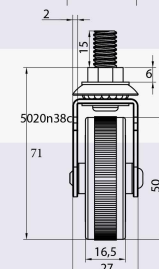
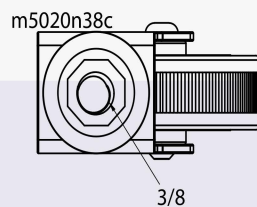
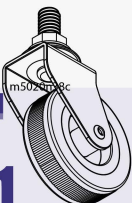

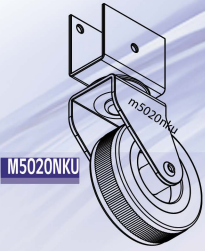

M5020NKU

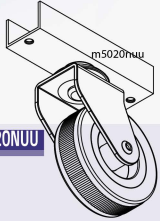
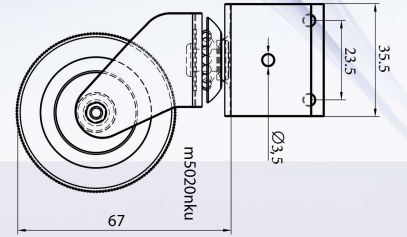
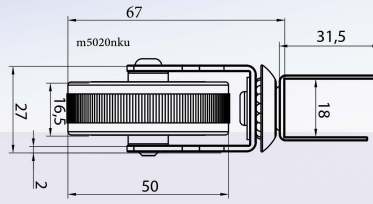
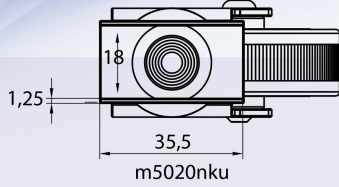

M5020NUU

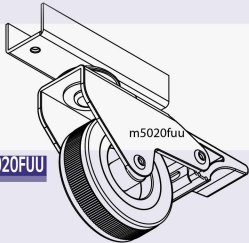
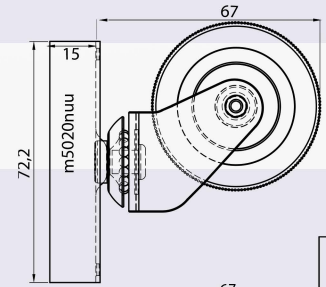
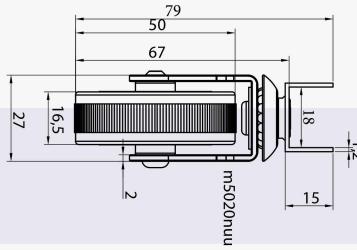
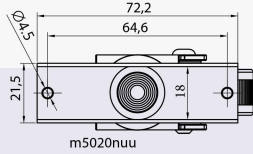

M5020FUU

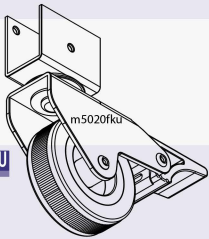
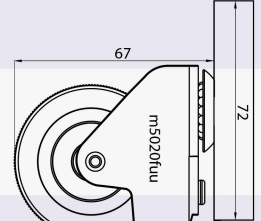
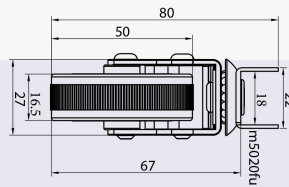
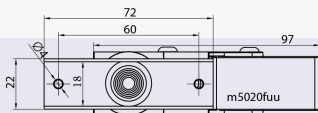

M5020FKU

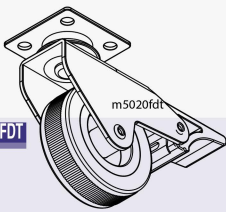
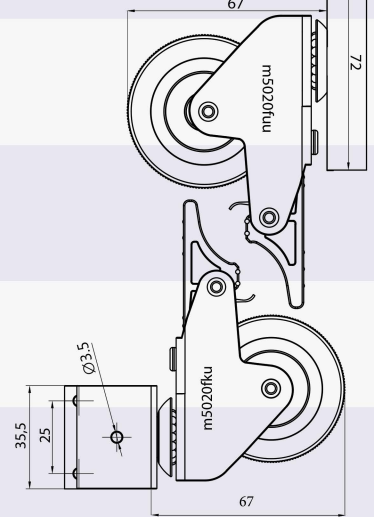
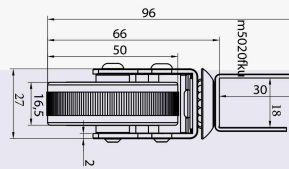
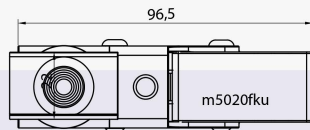

M5020FDT

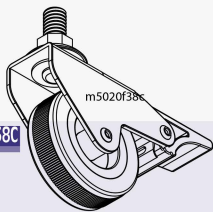
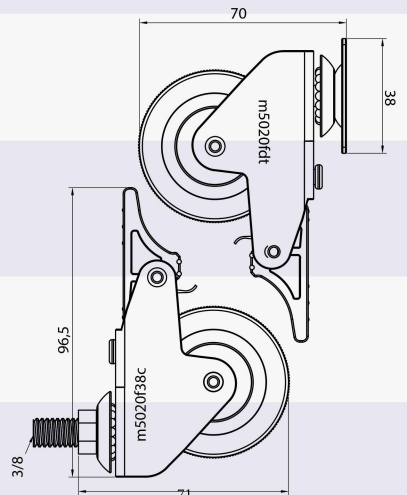
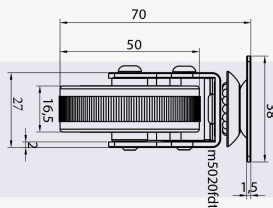
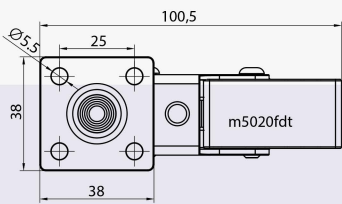

M5020F38C

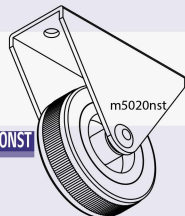
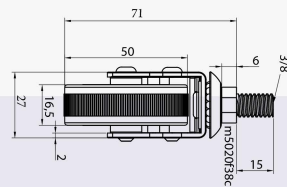
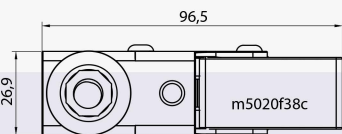

M5020NST

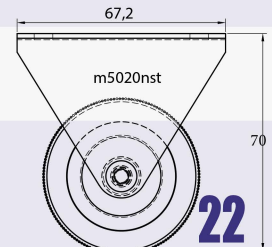
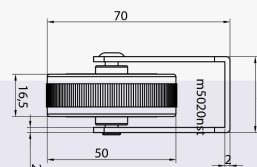
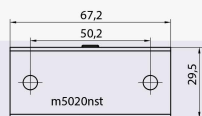



## **Address**

### **Head office**

Dersankoop Sanayi Sitesi , Trios A blok, -1. kat ,  
No:160 , 34490 İkitelli Osb.İstanbul /Turkey

### **Factory**

Dersankoop Sanayi Sitesi , Trios A blok, -2. kat ,  
No:145 , 34490 İkitelli Osb.İstanbul /Turkey

### **store**

Dersankoop Sanayi Sitesi , Trios A blok, -2. kat ,  
No:149 , 34490 İkitelli Osb.İstanbul /Turkey

Email: [info@erecturkey.com](mailto:info@erecturkey.com)  
Hotline: +90 850 340 44 99  
phone : +90 537 288 67 37  
phone : +90 552 602 52 09

